

2024

BIUROMAX
YOU FIRST

35
YEARS

AT YOUR SERVICE



RESELLER OF THE YEAR

SUPPLIER OF THE YEAR

Available in our offer

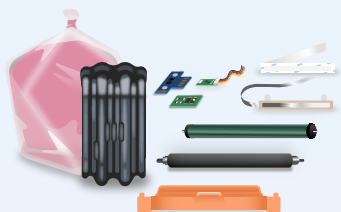

Components for remanufacturing

We supply all types of components necessary for remanufacturing of copiers and printers cartridges.



Remanufactured products

Environmentally friendly solutions offering high quality for competitive prices.

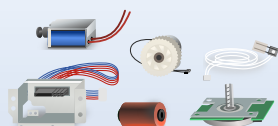

Service parts

Full catalogue of service spare parts in original and compatible version.

Extensive range of high quality components and service parts for printing devices

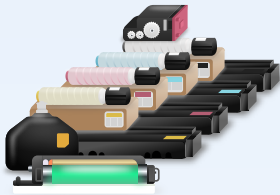

Alternative products

Based on components from leading manufacturers, which ensures print quality and patent safety.

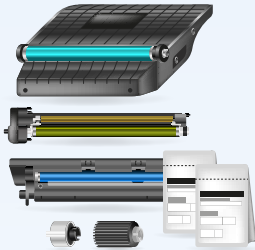

OEM

Toners, drums, developers
and spare parts for most popular brands.

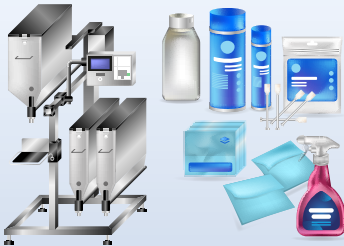

Complementary products

Lubricating oils, cleaners, vacuum cleaners,
filters, thermotransfer papers, multi-toner filling
machines and many more.

FOLLOW OUR SOCIAL MEDIA PROFILES



www.facebook.com/biuromax/



www.linkedin.com/company/biuromax/



www.instagram.com/biuromax_you_first/



Dear Friends, 2024 marks 35 years of Biuromax in business

Well, it's time for our big anniversary's summary. However, like in every yearly bulletin's entry, I'll try my best to be brief and not to bore you. Recent years have brought us all plenty of challenges, both globally and in Biuromax' closest perspective, which is European. The pandemic, war in Ukraine, perennial recession, and inflation – all of those have affected our personal and professional lives. Despite all the obstacles we are staying focused and are pushing forward in implementing our strategy and achieving our goals.

I can sum up last year with one word – busy. We have been focusing our efforts on actions – internal and external – aimed at improving our services. Our IT Department was strengthened with its “head”, Katarzyna. As a result, we have managed to prioritize tasks, provide several substantial changes and refinements in the digital field, including a brand new website, many improvements in our e-shop, such as new interface, new search engine, sections with recommended products. Another useful tool was establishing an internal IT ticketing system to make sure that any issues are solved as effectively as possible.

We have also taken a particular interest in our logistics. We have a Logistics Specialist as a permanent member of our Team. Stanislaw is working hand in hand with our Sales Team and making sure that our Clients are provided with the best possible options regarding pricing, delivery time, terms and conditions. Moreover, we have undergone a warehouse audit whose aim was to improve the efficiency of parcel packaging. All the audit's observations and recommendations have been not only implemented, but also taken into account in the construction of our new warehouse. More storage space means that we can provide our Clients with faster delivery time and a wider product range to choose from. It is also worth mentioning that our list of available carries is constantly expanding.

Our product offer is constantly expanding. We provide our Clients with a wide range, of which more and more are remanufactured goods and spare parts for copier and printer units. Biuromax is supporting sustainability, therefore we are not only a reman product seller, but also an educator. We believe that the print industry can be eco-friendly and we support accordant initiatives, such as The Right to Repair.

We are also an advocate for perceiving sustainability not as an obstacle, but rather as an opportunity.

Last but not least – we have intensified our marketing activities. Among many, developing our brand strategy deserves a special mention. I would like to thank all our Clients and Team who participated in surveys and interviews conducted during the beginning stages of our strategic work. You all have been very helpful and willing to share your thoughts and observations, which gave us a clear direction of our current and future actions.

Our plans for the foreseeable future are bold and ambitious, but we strongly believe that development is the basis of growth. Therefore, we are looking forward to entering new markets, expanding our Team and widening our product offer. In short – proving that our slogan “You First” isn’t just an empty phrase.

Although at the first glance the general prognosis for the print industry doesn’t look very optimistic (especially in regard to the rising cost of print, related decrease in print volume), I highly recommend you take a closer look at print trends. It may be an excellent opportunity to grow or alter your business so you can adapt to current market conditions.

Web-to-print, print on demand and 3D printing services are constantly growing in popularity, as they are an excellent tool for personalization – a feature highly demanded by the youngest generations of customers, as well as being eco-conscious. Sustainability,

as I’ve mentioned earlier, can be an opportunity, as an increasingly larger group of end clients and businesses are interested in eco-friendly solutions. I also would like to highlight the growing role of QR codes and labels, and their important role in e-commerce, which of course will not decrease for many years.

Thank you for the read and, of course, for being with Biuromax. 35 years under the belt and how many more to go? I bet many more with Partners and Friends like you.

And of course, I’d like to thank everyone who supported us in The Recycler 2023 Live Awards. Your votes have provided us with two greatly important titles – The Reseller of The Year and The Supplier of The Year. We promise to work hard to meet expectations in hopes of winning again this year!



Thank you again!

A handwritten signature in black ink that reads 'Dariusz Woźniak'.

Dariusz Woźniak
The CEO of Biuromax

| Table of Content

We operate globally, we support locally	7
We respond to your needs	8
Remanufactured products	10
Components for remanufacturing	12
Alternative products	14
Parts for printers and copiers	16
Original products	18
Complementary products	20
How do we respond to challenges?	22
10 reasons to be with us	24
New features in e-shop	27
Quality counts	32
Complaint process with RMAX	33
Remanufacturing up close	34
We are here for you	37
Trainings	38
Our product brochures	39
Virtual Room	40
Our Team	41
Biuromax' accomplishments	42

We operate globally, we support locally

A team of **75** people

35 years of experience

20 communication languages



We respond to your needs

In response to our Client's feedback regarding stock levels,
we have built an additional warehouse.

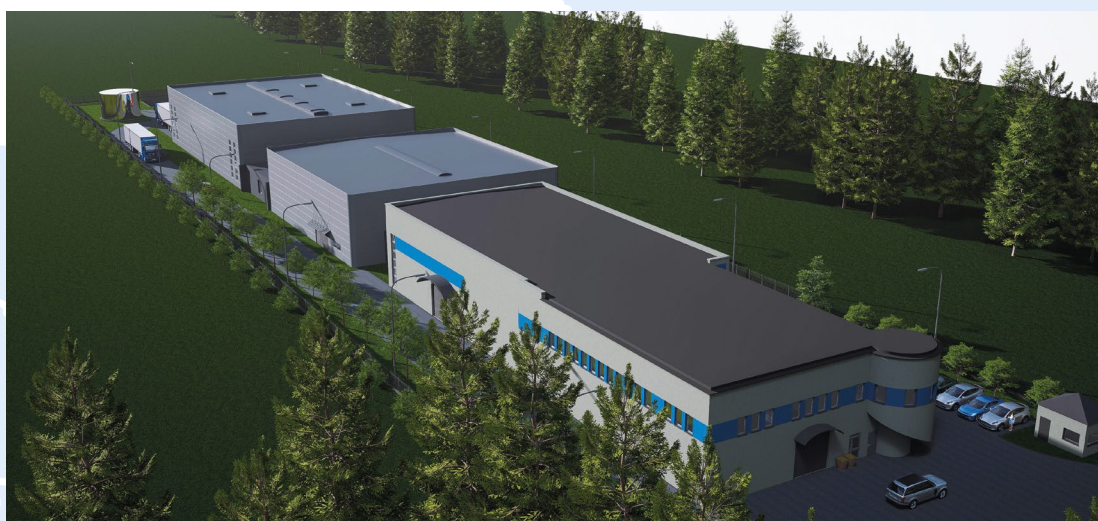

Our business' strenght is built on partnership.



Warsaw area,
Poland

We value your feedback.

Last year, as part of our brand strategy, we conducted a series of surveys and interviews. Based on our Clients and Team feedback we have begun implementing several major improvements. A brand new web page, new features and interface of our e-shop, enlarged warehouse – just to name a few.

Designing our processes we are always trying to provide the best solutions for each market, adopting its conditions and respecting legal regulations. Our prime location in the heart of Europe gives us the edge to deliver flexible logistics across the globe. Our multicultural and multilingual Team is our biggest strenght, providing us with various perspectives and ideas. We are close to our customers. Our representatives live and work in every region where we trade.

FOLLOW OUR SOCIAL MEDIA PROFILES



www.facebook.com/biuromax/



www.linkedin.com/company/biuromax/



www.instagram.com/biuromax_you_first/

Remanufactured products



Remanufactured products are good for the environment

Remanufactured products are based on used original cartridges or units. After replacing already used elements they are refilled and ready for next use.

Benefits of using remanufactured products:

- creation of local jobs
- environmental protection
- energy saving
- less industrial waste generated
- reduction of carbon dioxide emissions

While shopping, look for product with ECO certificates. Among the most respectable is ETIRA certificate.

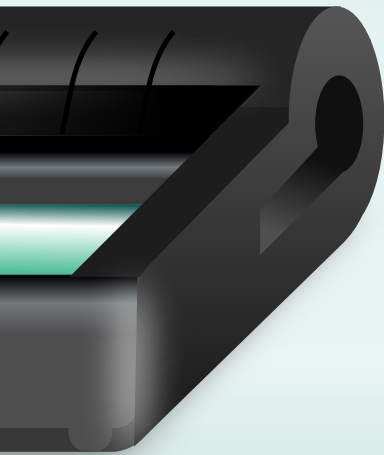

Biuromax' offer of remanufactured products includes:

- printer and copier drum units
- printer and copier toners
- transfer units
- fuser units

FOLLOW OUR SOCIAL MEDIA PROFILES

www.facebook.com/biuromax/ www.linkedin.com/company/biuromax/ www.instagram.com/biuromax_you_first/

Components for remanufacturing



How Biuromax supports environmental change?

- We are in continuous technical education to be the best support for our Clients.
- We are limiting the usage of single-use components.
- We are promoting products that can be recycled.
- We are educating our Clients about the advantages of reuse.

We work with the leading manufacturers of components for remanufacturing. This means that we have knowledge from the source itself – we are always **UP TO DATE** when it comes to market novelties. We also listen to the people who are most important to us in the process of creating our offer – our Clients.

During meetings and individual conversations we receive very important feedback, which allows us to adjust our assortment to real needs with great precision.

Biuromax' offer of components for remanufacturing includes:

- toner powders (conventional, polyester and chemical) and carriers in 1 kg bottles, dedicated weights and 10 kg bags
- OPC drums (with gears, with contact gears, without gears, with silencers)
- chips
- magnetic rollers and magnetic roller sleeves
- charge rollers (PCR)
- wiper and doctor blades, recovery and sealing blades
- plastic parts – hoppers, conversion kits, resetters, shipping covers/locks
- airbags

FOLLOW OUR SOCIAL MEDIA PROFILES



www.facebook.com/biuromax/



www.linkedin.com/company/biuromax/



www.instagram.com/biuromax_you_first/

Alternative products



We analyze the market of alternative products very carefully and we do not make any exceptions. If you see a product in our offer, it means that we are convinced of its quality while dealers and services of copying and printing devices use it all the time.

We will ensure their availability and competitive prices.

High and consistent quality of our alternative products is our priority. We rely on carefully selected components, which ensure print quality and patent safety.

Biuromax' offer of alternative products includes:

- finished and bulk toners
- compatible developers
- OPC drums
- fuser units
- drum units (new and remanufactured)
- wiper blades
- waste boxes



FOLLOW OUR SOCIAL MEDIA PROFILES

Parts for printers and copiers

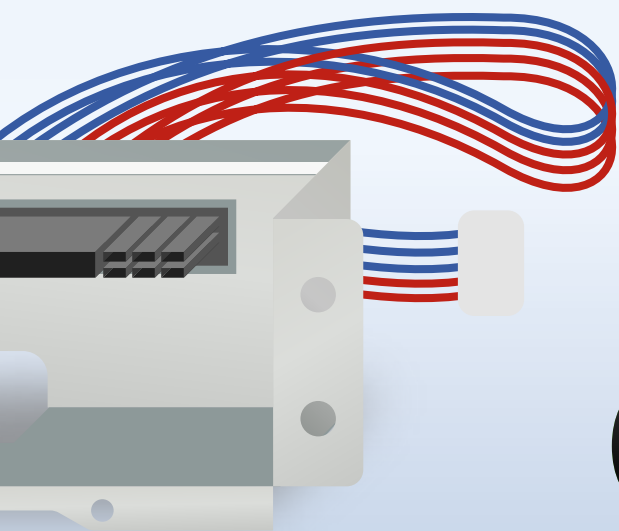
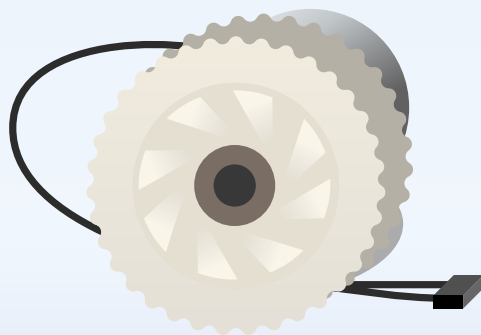
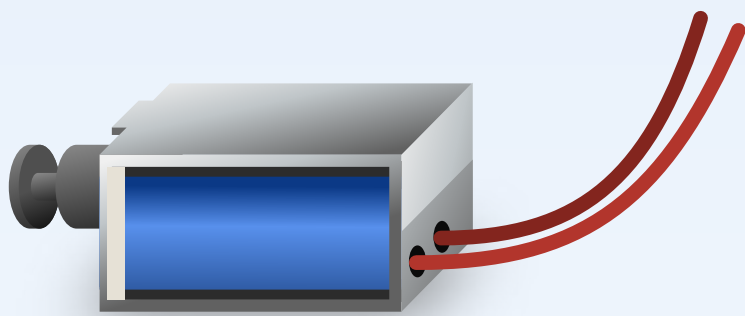

Our products ensure long and trouble-free operation of your equipment

We support professionals by providing a full catalogue of service spare parts in original and compatible versions. We pay special attention to the search for quality solutions. We guarantee continuity of supply.

Biuromax' offer of parts for printers and copiers includes:

- parts necessary for remanufacturing of transfer units – transfer belts, cleaning and lubrication blades
- parts necessary for remanufacturing of fuser units – upper, lower and cleaning rollers, fixing films, bearings, bushings, picker fingers, cleaning webs
- paper rollers – feed, pickup, separation
- parts necessary for remanufacturing of drum units – OPC drums, drum cleaning blades, lubricant application blades, drum lubricant bars, lubricant application brush rollers, charge rollers, PCR cleaning rollers

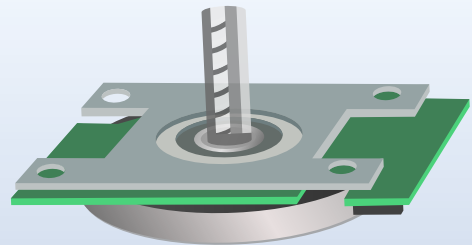
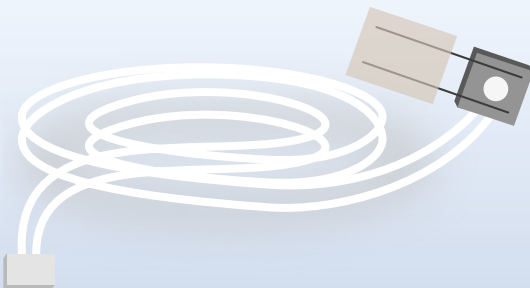

FOLLOW OUR SOCIAL MEDIA PROFILES



www.facebook.com/biuromax/



www.linkedin.com/company/biuromax/



www.instagram.com/biuromax_you_first/

Original products

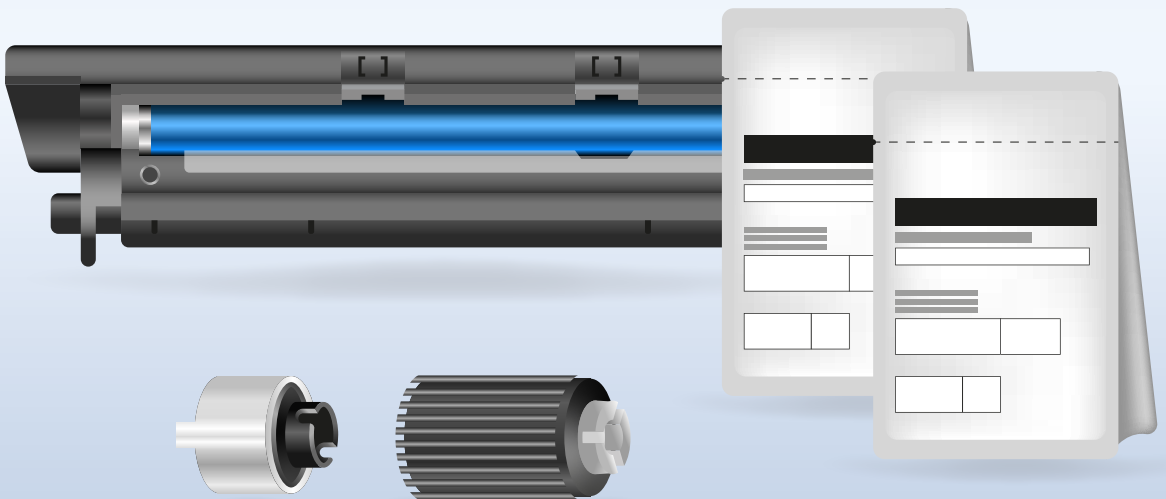
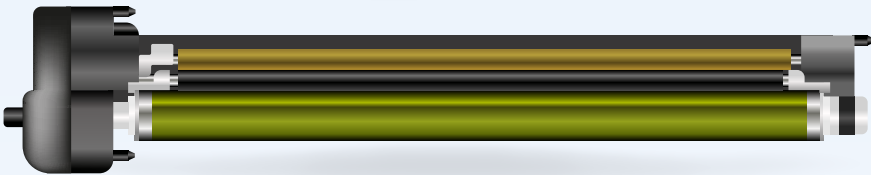
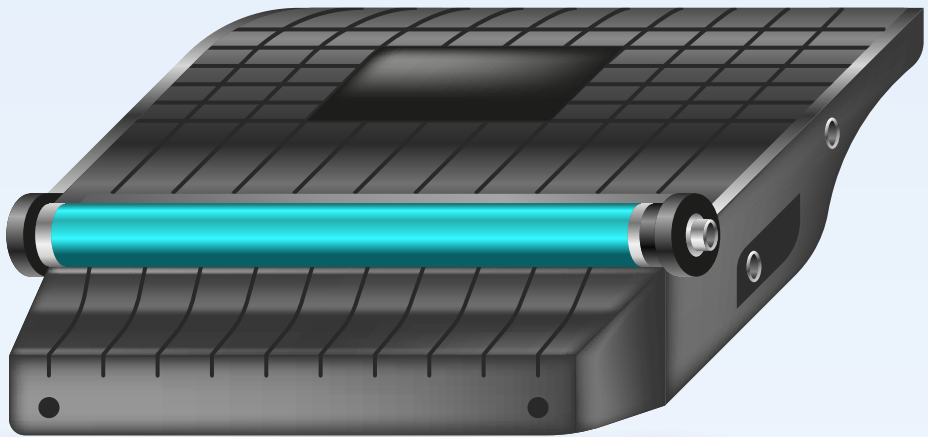

OEM products are an important part of our product range

You can choose from toners, drums, developers and spare parts for most devices.

The strongest part of our offer includes brands such as:

Konica Minolta, Ricoh, Canon, Kyocera, Toshiba, Sharp, HP, Xerox.

We pay attention to the authenticity of OEM products, which is why we have been cooperating for years with distributors and strictly selected suppliers, and the goods we offer are approved for sale in the European Union.



XEROX

Canon

SHARP



KONICA MINOLTA

TOSHIBA

RICOH

KYOCERA

Biuromax' offer of original products OEM includes:

- toners and ink cartridges
- drums and drum units
- developers
- developing units
- fuser units
- maintenance kits
- transfer units
- spare parts
- waste boxes

FOLLOW OUR SOCIAL MEDIA PROFILES



www.facebook.com/biuromax/



www.linkedin.com/company/biuromax/



www.instagram.com/biuromax_you_first/

Complementary products



How do we make technicians' work easier?

At Biuromax, we understand how complex and demanding the operation and service of printing equipment is. Our extensive experience, knowledge and frequent and exhaustive discussions with customers and suppliers are the best evidence of this.

That's why, in addition to high-quality products, detailed videos and technical manuals, we are constantly developing our range of accessories and tools essential to the work of every technician and other members of your Team.

Biuromax' offer of complementary products includes:

- critical cleaning supplies
- lubricants and powders
- fuser fixing film grease
- Convac toner vacuum cleaners
- vacuum filters & spare parts
- thermotransfer paper
- bottle caps & empty bottles
- toner filling machines
- toner cleaning stations

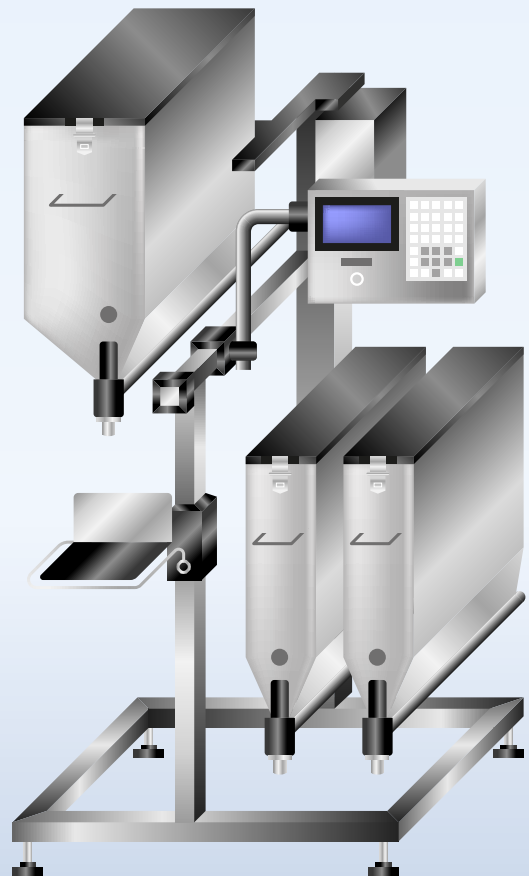

FOLLOW OUR SOCIAL MEDIA PROFILES



www.facebook.com/biuromax/



www.linkedin.com/company/biuromax/



www.instagram.com/biuromax_you_first/

How do we respond to challenges?



The last few years made us aware that we have to be constantly prepared for changes, especially for those unforeseen. We are keen on working with and for the print industry, to make sure that our future is as stable and predictable as possible. The key to success in our opinion is to create reality, not to be passive and in denial of our surroundings.

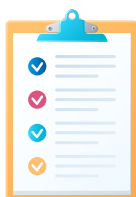

Feedback-focused approach

We listen to our Clients, Partners and Team. Aside from daily feedback we are conducting periodic surveys and interviews so that any problems are solved before they appear.



New Partners

Along with the expansion into new markets and acquiring new customers, we are intensively expanding the range of carriers. Thanks to this you have a guarantee of fast delivery and always competitive transport rates.



A larger Team

New people regularly join our Team, bringing invaluable experience, a fresh perspective and energy. They are individualists, true experts, perfectly cooperating within their departments.



Further investments

We continue to develop our IT tools to meet current and future market challenges. In addition, we have built an extension to our warehouse to provide even more efficient service to our customers.



10 reasons to be with us





We speak your language

Our team speaks many languages – including yours. This means easy communication and professional support whenever you need it.



We care about relationships

Relationships are most important to us. This applies both to relationships with Clients and our Staff. We play as a team to achieve a common goal – provide you with the best solutions in the field of printing consumables.

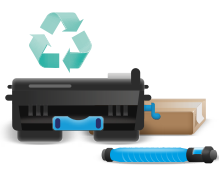

Wide product portfolio

You'll find what you need here. We have a whole range of products for printers and copiers: inks, toners and spare parts for popular brands.



We are close to you

Our headquarter is located in the middle of Europe. That is why our products reach almost every place on the continent just as quickly.



Immediate service

We are at your disposal. We respond to your call immediately.

FOLLOW OUR SOCIAL MEDIA PROFILES

www.facebook.com/biuromax/ www.linkedin.com/company/biuromax/ www.instagram.com/biuromax_you_first/



E-shop – wherever you are

Our online store is quick and convenient for placing orders. Whenever and wherever you want. The e-shop works at your own pace.



Same day shipping

We act immediately. If you order goods from us by 3 pm, we will send your consignment the same day.



Individual approach

We are flexible and always open to expanding our product range to meet your needs.



We know all about printing

We have been printing experts for 35 years. We know our products and your needs very well. We are constantly training and developing, so you can be sure that you are using the best solutions available on the market.



We appreciate loyal customers

Ask your Account Manager for individual loyalty programs and bonuses.

New features for your convenience

**E-shop
even better,
even more convenient**

We focus on daily personal contact. We use the latest technology. A dedicated Account Manager supports you from the first contact. In addition, the e-shop makes cooperation even more convenient.

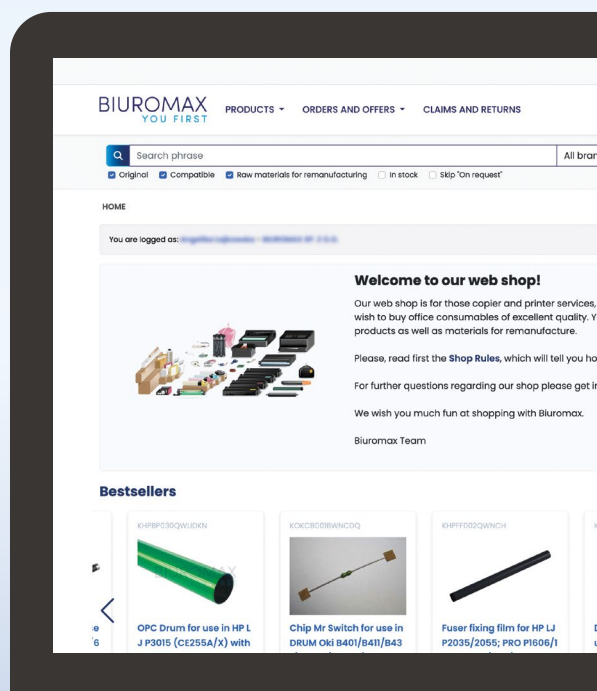

FOLLOW OUR SOCIAL MEDIA PROFILES



www.facebook.com/biuromax/



www.linkedin.com/company/biuromax/



www.instagram.com/biuromax_you_first/

e - s h o p

intuitive
search engine

new interface
and features

all product
details

access to technical
instructions

special offers
and promos

real-time
stock info

full purchase
history

easy access to
our complaint system

The screenshot displays the BIUROMAX e-shop interface. At the top, there are navigation links for PRODUCTS, ORDERS AND OFFERS, CLAIMS AND RETURNS, SHOPPING CART, and MY ACCOUNT. The main content is divided into three sections:

- We also offer:** A table with 4 entries showing compatible products. Each entry includes a code, a name, and a description. For example, KRIBP037QCKCH is an OPC Drum for use in Ricoh MPC3003/3503/4503/5503/6003, MPC3004/3504/4504/5504/6004 400k black, 270k color, single packed - COMPATIBLE PRODUCT. Other entries include KRIBP037QCKFUF, KRIBP037QCKFUF1, and KRIBP037QCKID.
- You may also need:** A table with 4 entries showing related products. For example, KRIBJ004RCKHS is a Remanufactured Drum Unit for use in Ricoh MPC3003/3503/4503/5503/6003 (D1862258) black 300k - COMPATIBLE PRODUCT. Other entries include KRIBU004VCKHS, ORIBU050BWK, and CRIBU050VWK.
- Product can be used in:** A table with 4 entries showing devices and sections. For example, Ricoh MPC3003 is used in PCDU - Zespól obrazowy - BLACK [D1862200]. Other entries include Ricoh MPC3003 (Cyan and Magenta), and Ricoh iMX-3003.

Use all the advantages of e-commerce

In our e-shop you can manage your purchases even more effectively and plan sales and service activities.

Get a special quote

1. choose products
2. send your inquiry
3. your Account Manager will prepare an offer specially for you

Find what you need in the blink of an eye

1. select the machine model
2. select a section in the machine
3. choose the original or compatible parts that you need
4. place an order

Don't miss out on promotions and the most important information.

Subscribe to our newsletter and add us to your trusted senders.

You will gain access to weekly promotions and periodic special offers as well as market news and organisational updates.

Technical support

We are frequently releasing new videos and instructions to make service activities based on our solutions intuitive and user-friendly. The videos cover a range of topics relating to the maintenance, operation and replacement of components in printing devices.

Can't find the instruction you're looking for? Our Team will provide you with the individual consultation, training or other support you need. Just let us know.

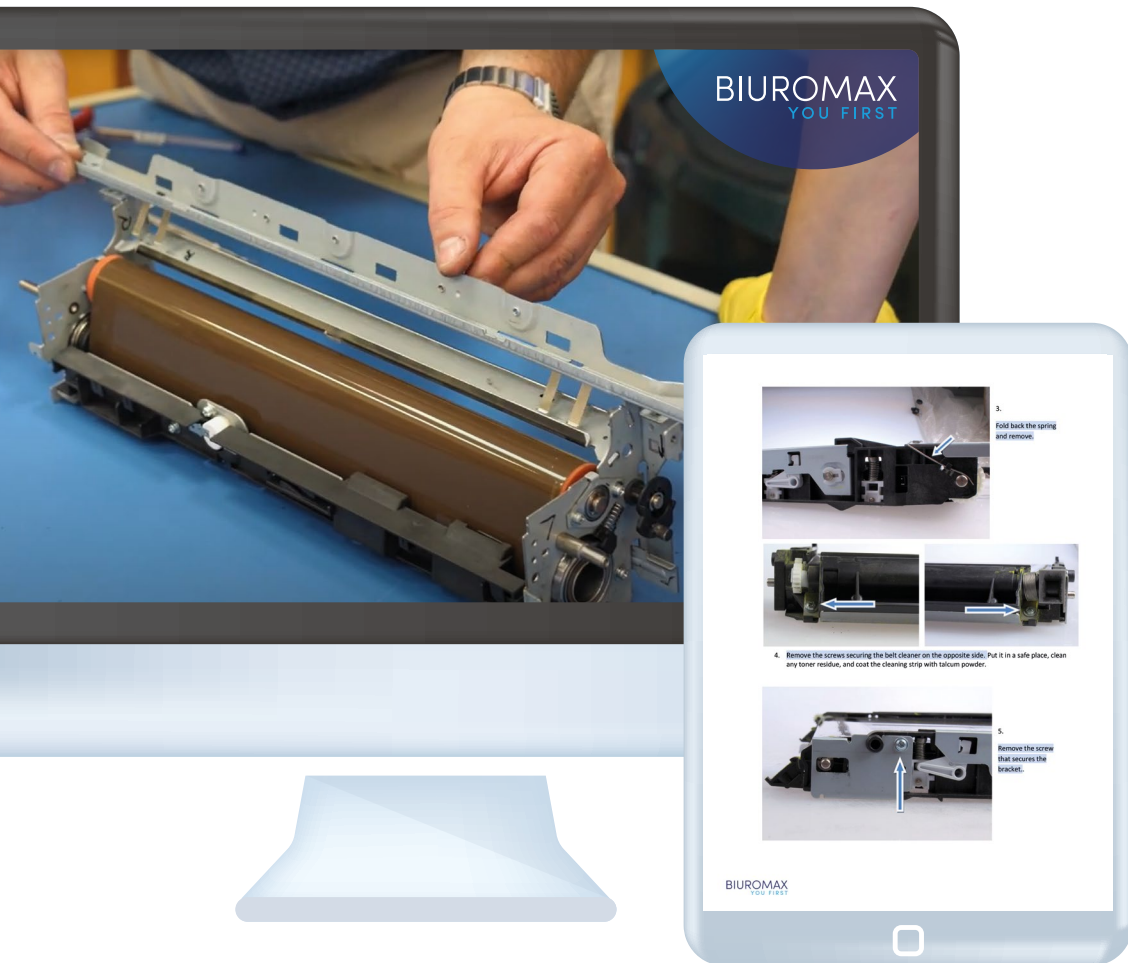

Client satisfaction survey

Direct information from our Clients is what we value the most. Based on your feedback we can eliminate mistakes, make changes and decide on future developments.

Therefore we have created a dedicated satisfaction survey subpage. We highly encourage you to enter it anytime and provide us with your valuable opinion.

[Click here](#) and complete Client satisfaction survey

The screenshot shows a laptop displaying the BiuroMax website's satisfaction survey page. The page has a dark blue header with the BiuroMax logo (a white circle with 'BIUROMAX YOU FIRST' inside) on the left and navigation links (HOME, ABOUT, COOPERATION, PRODUCTS, NEWS, CONTACT, SATISFACTION SURVEY) on the right. The main content area is white and contains the following questions:

- ARE YOU A CUSTOMER OF BIUROMAX?**
 - Yes
 - No
- HOW DID YOU FIND OUT ABOUT BIUROMAX?**
 - From the Internet
 - During the trade fair
 - Via command
 - A Biuromax salesman got in touch with me
- HOW WOULD YOU RATE YOUR COOPERATION WITH A BIUROMAX SALESMAN?**
 - Bad
 - Poor
 - Fair

FOLLOW OUR SOCIAL MEDIA PROFILES



www.facebook.com/biuromax/



www.linkedin.com/company/biuromax/



www.instagram.com/biuromax_you_first/

Quality counts

Every product in our range undergoes two quality checks. The manufacturers we work with carefully test their products before they go into mass production. Thanks to this you can be sure that your printing devices will work at the highest level and remain in perfect condition.

In cases requiring analysis of toners at the elementary, molecular level, we cooperate with leading scientific institutes. Using their potential we can test our products for organic compounds, carry out elemental analysis, metal content analysis or look at the size and shape of toner particles.

Our products are also tested for performance. The tests we carry out are performed in accordance with test procedures based on ISO standards:

- Inkjet cartridges - ISO/IEC 24711
- Mono toners - ISO/IEC 19752
- Colour toners - ISO/IEC 19798

Specially prepared test cards are used during the tests. Thanks to this, the results are reliable and the client can be sure that each toner offered by Biuromax has undergone comprehensive tests and meets the quality and efficiency criteria.

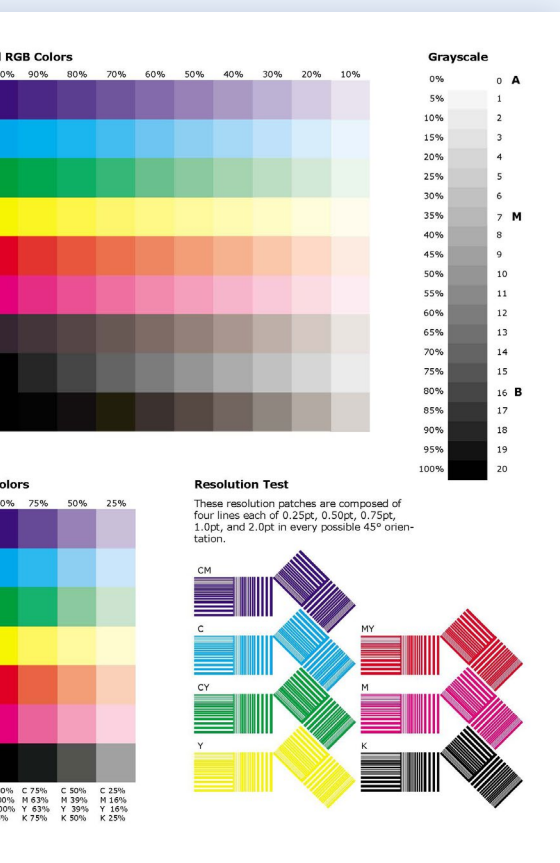

[CLIK AND CHECK OUT OUR
TECHNICAL INFORMATION SUBPAGE](#)

If something goes wrong...

making a complaint is easy!

Please, remember:

- You can make a complaint up to 12 months from the date of receipt.
- You can return the goods up to 10 days from the date of receipt.
- Always check the parcel for signs of damage.
- In case of damage, fill in a damage report with the participation of the representative of the shipping company (ask for a template) and notify your Account Manager.

Our RMAX claim procedure

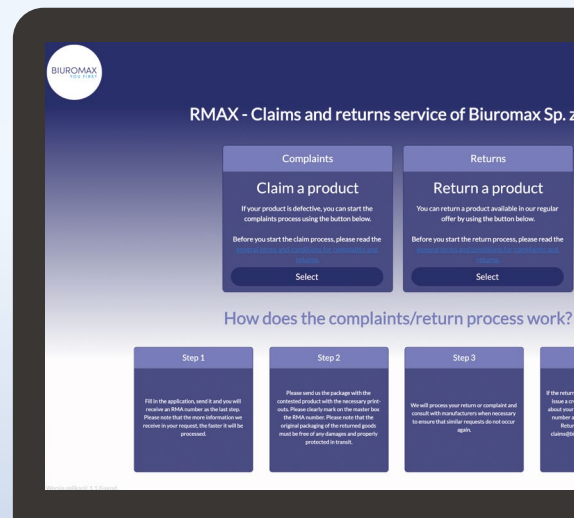

FOLLOW OUR SOCIAL MEDIA PROFILES

www.facebook.com/biuromax/ www.linkedin.com/company/biuromax/ www.instagram.com/biuromax_you_first/

| Remanufacturing

**high quality
and competitive price**

Remanufacturing – what is it?

Remanufacturing gives products a second life. Not all parts wear out in the same way. During the remanufacturing process the functional parts are used again and only worn out elements are replaced. In this way it is as good as the original, but at a lower price.

Which products can be remanufactured?

- cartridges
- drum units for printers and copiers
- fuser units
- transfer units
- developer units
- other parts

Remanufacturing up close

See how the process works



Disassembly of individual components

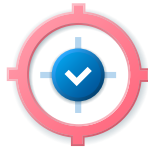

Thorough removal of any residual toner or ink



Technical evaluation of re-usability



Installation of new parts and components



Refilling of toner or ink in cartridges

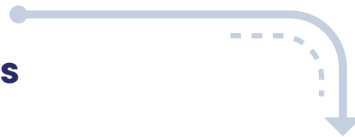

Test to check the print quality and correct operation



Protection and packaging of the remanufactured product

What is new in a remanufactured product?

Elements to be replaced:

- OPC drums
- PCRs
- wiper blades
- doctor blades
- recovery blades
- magnetic and developer rollers
- chips
- other additional parts that ensure proper operation and durability of remanufactured units

Benefits of professional remanufacturing:

- ✓ helps to protect environment
- ✓ ensures long product life and high quality of printouts
- ✓ guarantees safe and trouble free operation of equipment
- ✓ reduces your printing and copying expenses
- ✓ the use of enlarged toner cartridges can substantially increase the number of copies and thus reduce the frequency of cartridge replacement

Remanufactured products in Biuromax offer

Advantages of Biuromax' remanufactured products:

- ✓ we guarantee the highest quality of remanufactured components and products
- ✓ we are always up to date with market changes
- ✓ we cooperate with leading manufacturers of components for remanufacturing, therefore we have access to a wide portfolio of products
- ✓ we listen to the needs of people who are most important to us – our Clients

VISIT OUR WEB PAGE AND E-SHOP

 www.biuromax.com.pl  shop.biuromax.com.pl

We are here for you

Diversified Team is the result of many individuals

For years we have been focusing on diversity. In Biuromax, above all skills, commitment and passion are important. We select our employees with these values in mind. We create conditions in which we can all cultivate these values on the basis of mutual support, integration and solidarity. The interaction of different ways of thinking and different ideas for solving problems creates out-of-the-box scenarios and enhances innovation.

Benefits of diversity:

- a better understanding of customer needs
- flexible approach
- greater team efficiency
- good atmosphere and excellent team relations
- easy crisis handling

FOLLOW OUR SOCIAL MEDIA PROFILES



www.facebook.com/biuromax/



www.linkedin.com/company/biuromax/



www.instagram.com/biuromax_you_first/

| Trainings

Competence development and personal skills of the Team are very important to us. For the last few years, we have been participating in trainings on selling skills, building relations with Clients and savoir-vivre. On the other hand, changes on the European market required us to have knowledge and familiarity with new customs clearance rules.

We systematically update our knowledge in the field of personal data protection. We have also developed our mentoring and onboarding standards. We are constantly discovering and learning about market novelties in order to be always up to date for you. Despite our solid position on the market, we are still curious, hungry for knowledge and eager to learn new approaches to business.



**We are constantly learning
in order to better meet
your expectations!**

| Our product brochures

Are you looking for spare parts for printing devices of brands Canon, Konica Minolta, Ricoh, and Sharp? That's great because it is with our customers' needs in mind that we have gathered catalogues of compatible products available in our e-shop in one place.

BIUROMAX
YOU FIRST

Konica
Minolta

compatible
products
catalogue

SCAN QR CODE AND DOWNLOAD THIS BROCHET →



BIUROMAX
YOU FIRST

Ricoh

compatible
products
catalogue

SCAN QR CODE AND DOWNLOAD THIS BROCHET →



BIUROMAX
YOU FIRST

Canon

compatible
products
catalogue

SCAN QR CODE AND DOWNLOAD THIS BROCHET →



BIUROMAX
YOU FIRST

Sharp

compatible
products
catalogue

SCAN QR CODE AND DOWNLOAD THIS BROCHET →



[CLICK HERE](#)
AND VIEW OUR CURRENT BROCHURES

Virtual Room



**We invite you to join us for a virtual coffee
in our Virtual Room. Click the link below
to book a meeting with Biuromax Team.**

[CLICK HERE!](#)

Our Team

Click the name of the department to access contact details on our web page.

Domestic Sales Department

Administration & Finance

Import Department

Complaints Department

Export Department

Warehouse

Business Development & Marketing

Quality Control Department

Transport & Logistics Department

IT Department

Biuromax' accomplishments

Since 2017, we have been regularly recognized at The Recycler's annual awards ceremony, which aims to honour and celebrate outstanding companies and individuals who have made significant contributions to the recycling sector.



Follow our social media profiles to stay up to date with Biuromax!



www.facebook.com/biuromax/



www.linkedin.com/company/biuromax/



www.instagram.com/biuromax_you_first/

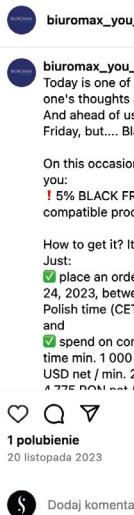

Also, we highly encourage you to sign up to our newsletter.

[Click here](#) or contact our Client Service Team to enter a subscribers list!



BIUROMAX

YOU FIRST



BIUROMAX Sp. z o.o.
Solec 156 A
05-532 Baniocha, Poland

Tel.: +48 22 735 44 44

export@biuromax.com.pl
www.biuromax.com.pl